

TVU12040R1B4 Engineering Specification



1. Scope

This specification is applied to protect sensitive electronic circuits from the threat of electrostatic discharge (ESD). The function meets with the requirement of IEC61000-4-2 specification. The extreme low capacitance is suit for HDMI ESD protection application. According to the special property of device, we recommend not to use on such application as: DC/AC power line.

Feature

- Protection against ESD voltages and currents (IEC61000-4-2 Level 4)
- Extremely quick response time (<1ns) present ideal ESD protection
- Extremely low capacitance (0.1pF typical)
- Extremely low leakage current
- SMD (Surface Mount Device)
- Zero signal distortion
- Lead Free, RoHS Compliance

Applications

TVU12040R1B4 is applied to high speed signal interface.

- USB 3.0
- HDMI
- Displayport
- MIPI
- LVDS
- MDDI
- DVI
- RGB

Product Model

- Digital Video Equipment
- Mobile Phone
- GPS Antenna
- Bluetooth Communication Equipment

2. Explanation of Part Number

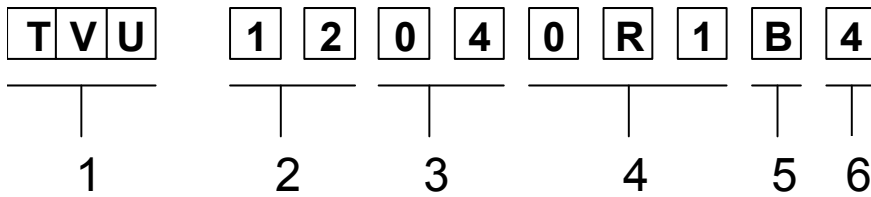

- ◆ 1 : TVU : ultra capacitance
- ◆ 2 : Working voltage:VDC 12V
- ◆ 3 : Channel : 2 channels
- ◆ 4 : Capacitance: 0.1pF
- ◆ 5 : Chip size:L:1.6mm W:1.0mm
- ◆ 6 : Type
- ◆

3. Circuit symbol

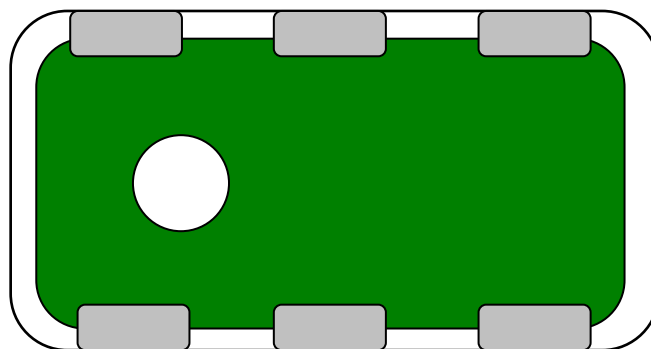
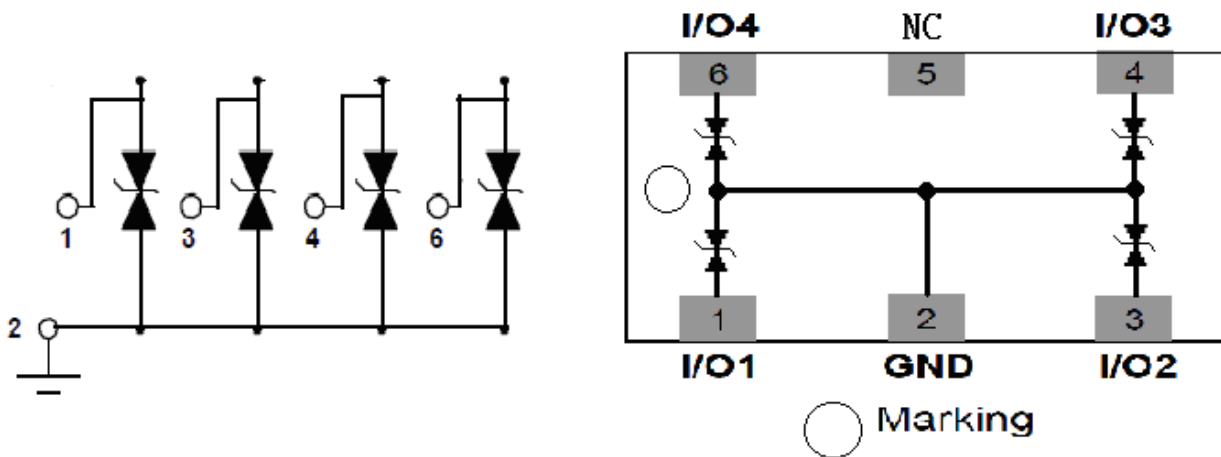

4. Construction & Dimensions

4.1. End termination: Ag/Ni/Sn

4.2. Construction & Dimension :

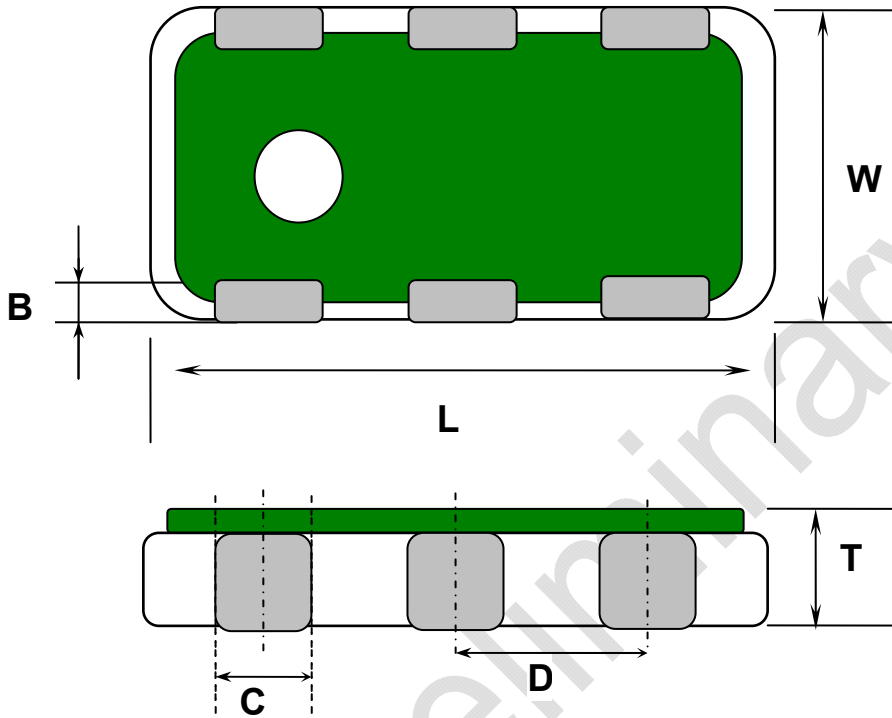

Unit: mm

L	W	T	B	C	D
1.60±0.10	1.00±0.10	0.55±0.10	0.20±0.10	0.20±0.05	0.50±0.05

Overcoat color: Green

5. General specifications

5.1. Temperature Specifications

Operating Temperature range	: -55°C to + 125°C
Storage Temperature range	: -55°C to + 125°C

6. Performance Characteristics

Characteristic	Value
Rated voltage (max)	12V
Leakage current (max) (@12VDC)	0.01μA
Trigger voltage (Vt)	300V typical
Clamping voltage (Vc)	30V typical
Capacitance (Cp), @1MHz	0.1pF typical
Response time	<1ns
ESD voltage capability, IEC 61000-4-2 Contact discharge mode	8KV
ESD voltage capability, IEC 61000-4-2 Air discharge mode	15KV
ESD withstand pulses	1000 typical

Cp – Device capacitance measured with 1Vrms

7. HDMI Interface Application

HDMI block Diagram

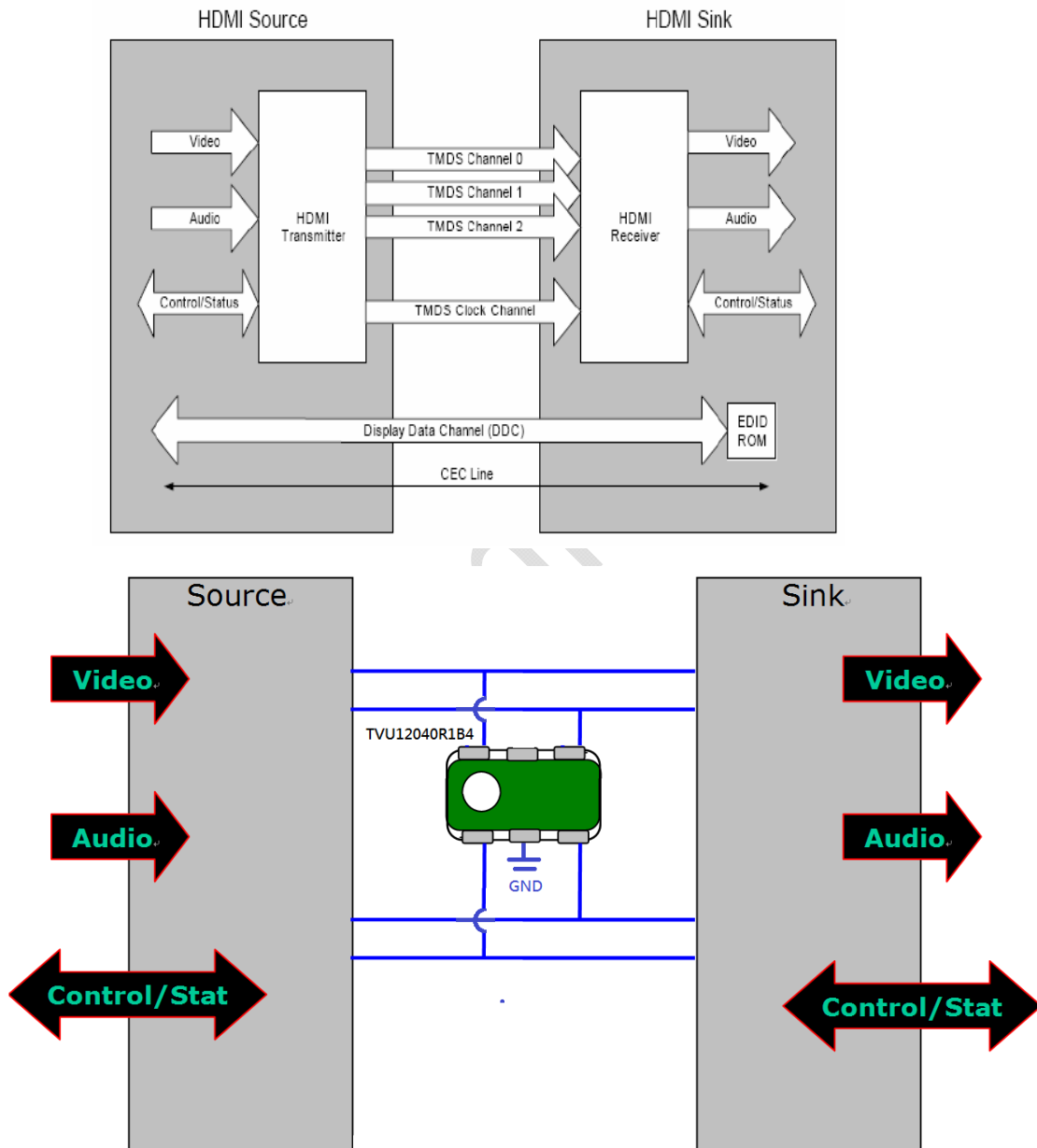

8. Taping Package and Label Marking

8.1. Packaging method

8.1.1. Products shall be heat-sealed in the chip pocket, spacing pitch 2-mm of paper carrier tape with cover tape, and the carrier tape shall be reeled to the reel.

8.1.2. Tape material to be paper. Tape thickness to be 0.75 ± 0.05 mm.

8.1.3. Cover tape adhesion to be 35 ± 25 grams.

8.2. Carrier tape dimensions

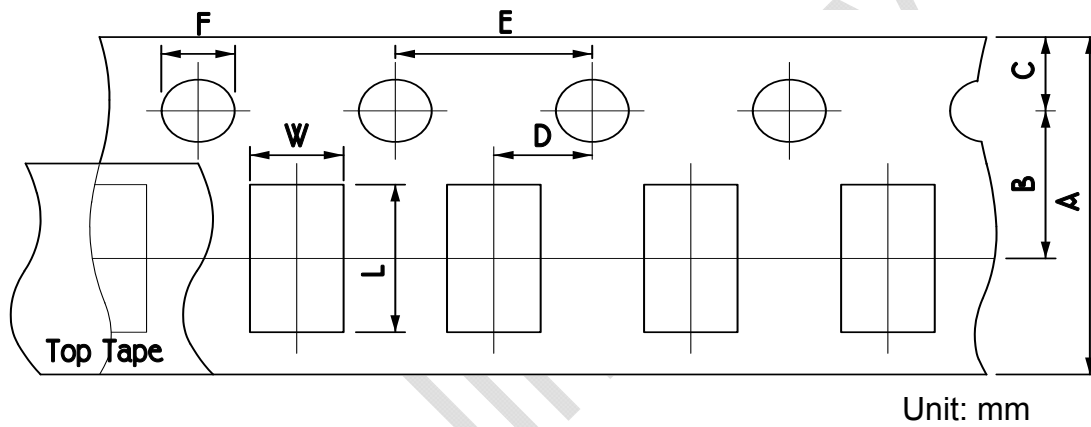

A	8.00 ± 0.30
B	3.50 ± 0.05
C	1.75 ± 0.10
D	2.00 ± 0.05
E	4.00 ± 0.10
F	1.50 ± 0.10
L	1.80 ± 0.15
W	1.25 ± 0.15

8.3. Taping reel dimensions

Unit: mm

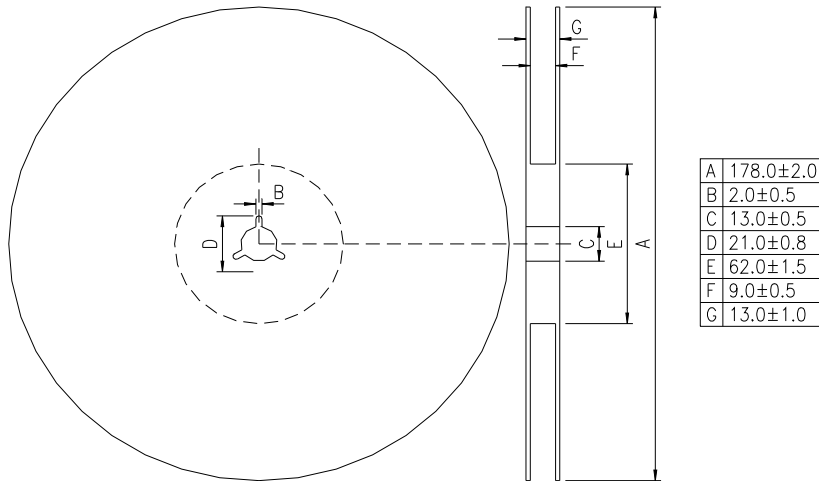

8.4. Taping specifications

There shall be the portion having no product in both the head and the end of taping, and there shall be the cover tape in the head of taping.

8.5. Label Marking

The label specified as follows shall be put on the side of reel.

- (1) Part No.
- (2) Quantity
- (3) Lot No.

* Part No. And Quantity shall be marked on outer packaging.

8.6. Quantity of products in the taping package

- (1) Standard quantity : 5000pcs/Reel
- (2) Shipping quantity is a multiple of standard quantity.

9. Precautions for Handling

9.1. Solder cream in reflow soldering

Refer to the recommendable land pattern as printing mask pattern for solder cream.

- (1) Print solder in a thickness of 0.1 to 0.15 mm.

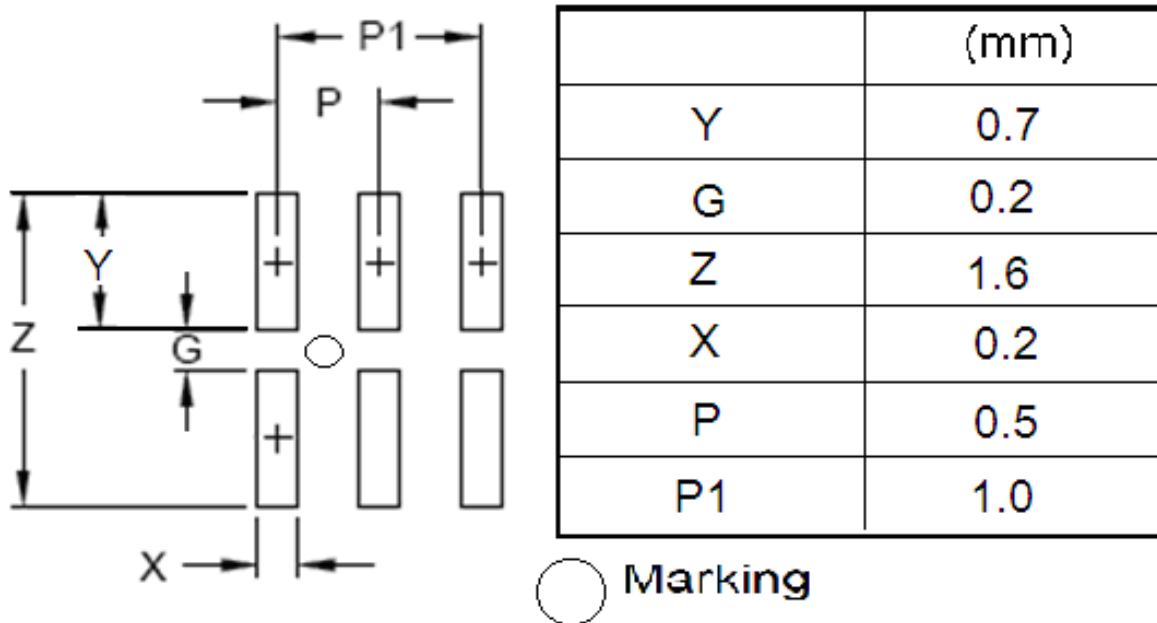

9.2. Precaution for handling of substrate

Do not exceed to bend the board after soldering this product extremely. (reference examples)

- Mounting place must be as far as possible from the position, which is close to the break line of board, or on the line of large holes of board.
- Do not bend extremely the board, in mounting another components.
If necessary, use back-up pin (support pin) to prevent from bending extremely.
- Do not break the board by hand. We recommend to use the machine or the jig to break it.

9.3. Precaution for soldering

Note that this product will be easily damaged by rapid heating, rapid cooling or local heating. Do not give heat shock over 100°C in the process of soldering. We recommend to take preheating and gradual cooling.

9.4. Recommendable reflow soldering

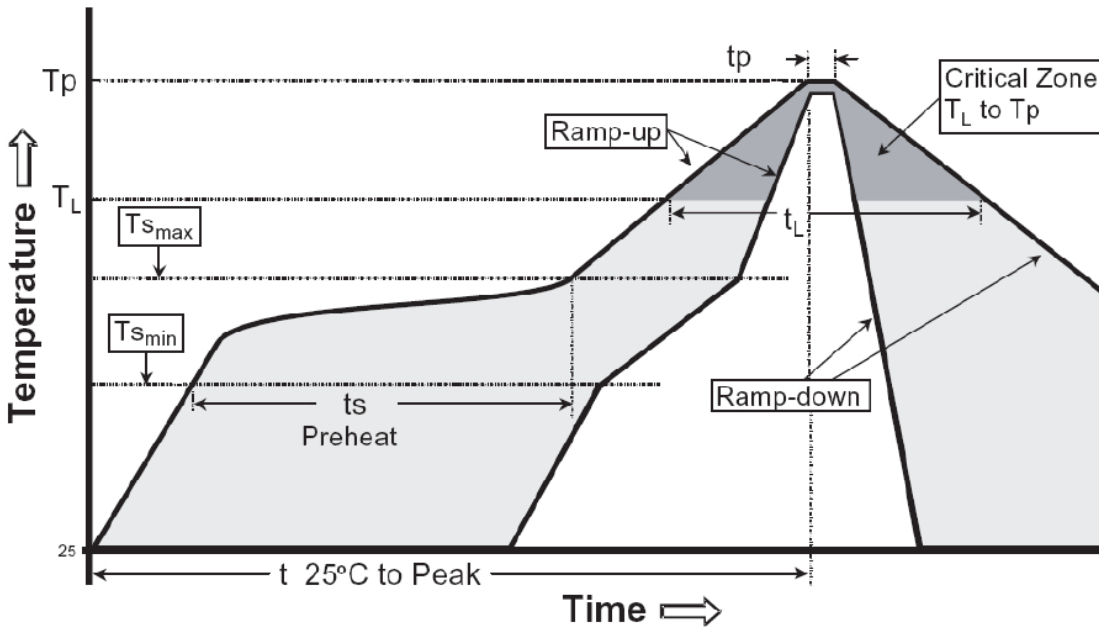

Reference IPC-STD-020D.1-5-2

Profile Feature	Pb free Assembly
Average Ramp Rate (Ts max to Tp)	3 °C/second max
Preheat	
- Temperature Min (Ts _{min})	150 °C
- Temperature Min (Ts _{max})	200 °C
- Time(ts _{min} to ts _{min})	60-180 seconds
Time maintained above:	
- Temperature (TL)	217 °C
- Time (tL)	60-150 seconds
Peak Temperature (Tp)	260 °C +0/-5 °C
Time within 5 °C of actual Peak Temperature (Tp)	30 seconds (Tolerance for peak profile temperature (Tp) is defined as a supplier minimum and a user maximum.)
Ramp-Down Rate	6 °C/second max.
Time 25 °C to Peak Temperature	8 minutes max

9.5. Soldering gun procedure

Note the follows, in case of using solder gun for replacement.

- (1) The tip temperature must be less than 280°C for the period within 3 seconds by using soldering gun under 30 W.
- (2) The soldering gun tip shall not touch this product directly.

9.6. Soldering volume

Note that excess of soldering volume will easily get crack the body of this product.

9.7. Taping Package Storage Condition

Storage Temperature : 5 to 40 °C

Relative Humidity: < 65%RH

Storage Time : 12 months max

Preliminary